

INSTALLATIONS INSTRUCTIONS

L1000
Pushbutton Access Control

**Version
English/
French**

Please keep these instructions. The combination of this lock has been factory preset: 2 and 4 pressed together, then 3.

WARNING

For your security, the combination must be changed at time of installation.

PLEASE READ AND FOLLOW ALL DIRECTIONS CAREFULLY

Since correct installation is critical, carefully check windows, frame, door, etc. to make sure that the recommended procedures will not cause any damage.

HICO UNICAN is not responsible for any damage caused by installation. H1000 Series locks are handed at the factory and cannot be changed in the field.

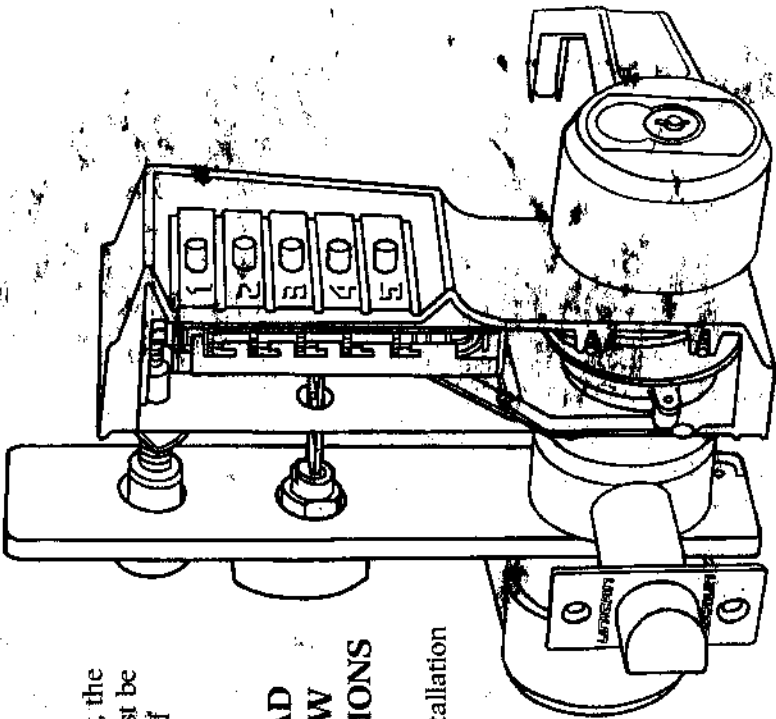

UNICAN
Canada and International Dominion Lock Division
7301 Decarie, Montreal, Quebec H4P 2G7, Canada
Tel.: (514) 735-5411 Fax: (514) 735-4704
Export fax: (514) 735-1393

U.S.A. Simplex Access Control Division
2941 Indiana Ave., Winston Salem, NC 27105 U.S.A.
Tel: (910) 725-1331 Fax: (910) 725-3269

INSTRUCTIONS D'INSTALLATION

Contrôle d'accès à
boutons-poussoirs
L1000

**français/
anglais**

Veuillez conserver ces instructions. La combinaison de cette serrure a été pré réglée à fusine : appuyer sur le 2 et le 4 ensemble... puis sur le 3.

AVERTISSEMENT

Pour votre sécurité, vous devez changer la combinaison de la serrure au moment de l'installation.

VEUILLEZ LIRE ATTENTIVEMENT LES INSTRUCTIONS

Vous assurer que l'installation de la serrure ne causera aucun dommage à la fenêtre, au jambage ou à la porte.

HICO UNICAN décline toute responsabilité pour tout dommage résultant de l'installation.

La main des serrures de la série L1000 est définie à fusine et ne peut être changée.

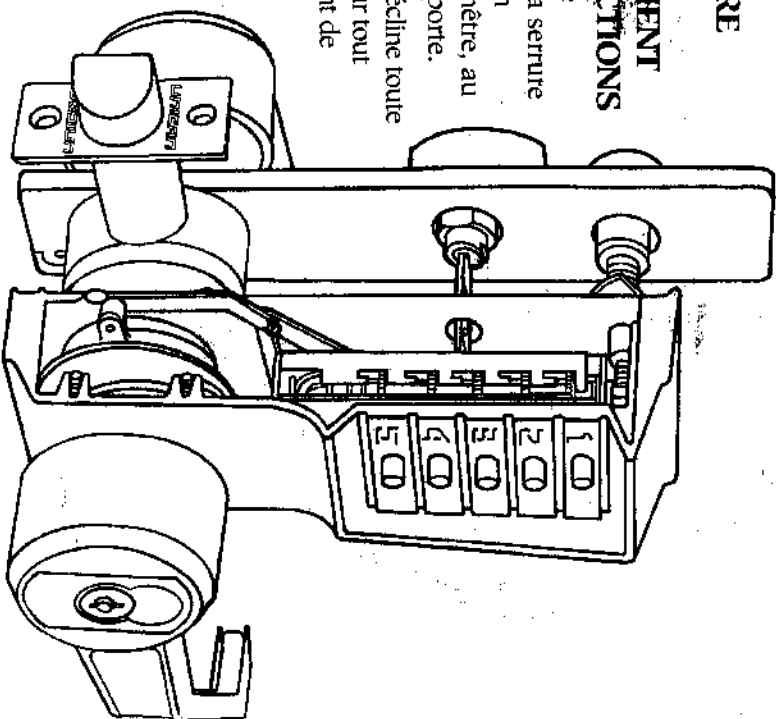

UNICAN

Canada et l'étranger : Division Dominion Lock-
7301, Décarie, Montréal (Québec) H4P 2G7 Canada
Tel. : (514) 735-5411 Téléc. : (514) 735-4704
Télécopieur à l'exportation : (514) 735-1393
États-Unis : Division Simplex Access Controls
2941 Indiana Ave., Winston Salem, NC 27105 U.S.A.
Tel. : (910) 725-1331 Téléc. : (910) 725-3269

TABLE OF CONTENTS

Table of Contents

STEP	PAGE
1	2
2	2
3	3
4a	3
4b	4
5	4
6	5
7	5
8	6
9	6
10	7
11	7
12	8
	center of book

APPENDIX

	PAGE
A	9
B	10
C	11
D	12
E	13
F	16

CHECKLIST

Each L1000 Series lockset includes the following items:

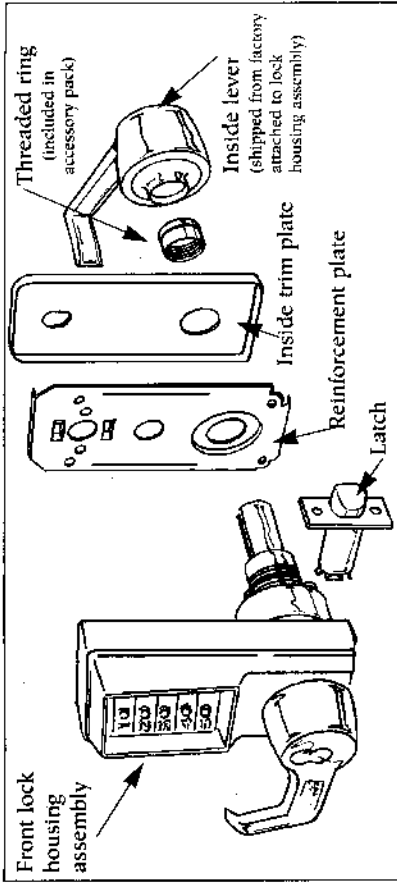

front lock housing assembly

reinforcement plate

inside trim plate

latch

screw/accessory pack:

A) dust box

B) strike plate

C) combination change plug assembly

D) two DF59 keys

E) threaded ring

F) extra spacer

G) rubber bumpers

H) one extra cross pin

I) spanner wrench

J) four 8-32 x 3/4" (19 mm) Phillips combination screws (for latch and strike)

K) four 8-32 x 3/16" (5 mm) Phillips sems screws (for cylindrical drive unit)

L) four 8-32 x 1/4" (17 mm) Phillips sems screws (for cylindrical drive unit)

M) two 8-32 x 2 1/2" (64 mm) screws (for mounting)

warranty card

Models 1031, 1041 only

passage set turn knob assembly

P) retainer clip for passage set

Models 1051, 1061 only

passage set plug assembly with

two DF-5 keys

P) retainer clip for passage set

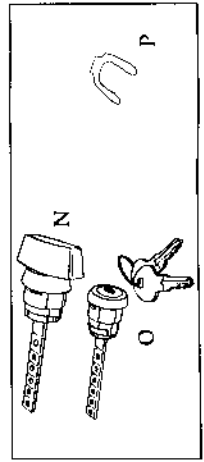
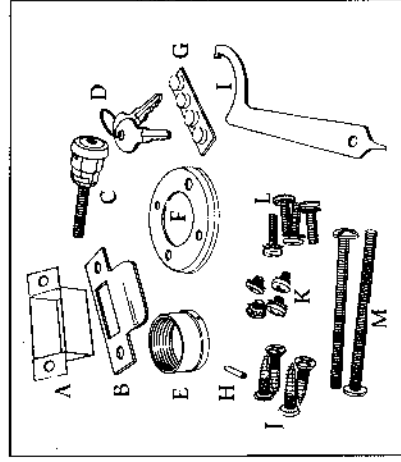

Templates are included
in the middle of this booklet

FOR YOUR RECORDS

Model No.: _____

Date Purchased: _____

Dealer: _____

Name: _____

Tel.: _____

MARKING THE DOOR

1

The door to frame relationship is critical for the performance and durability of the ILCO UNICAN latch mechanism. The vertical and horizontal center lines are important when positioning the lock, the strike, and the latch, and must be according to ANSI standard A115.2.

- 1 • Hold the paper template (found in the middle of this booklet) as indicated. Models without passage feature (L1011, L1021) use template A; models with passage feature (L1031, L1041, L1051, L1061, L1071) use template B.

- 2 • Tape the template securely to the door so that all the indicated folds are properly aligned with the high beveled edge of the door.

CAUTION: When a frame has an existing strike, be sure to locate the strike template so that the latch hole center is directly aligned with the center of the strike cutout.

- 3 • Mark the door as indicated on the template. Models without passage feature require 5 holes (template A); models with passage feature require 6 holes (template B). See Figure 1-1.
- 4 • Remove the template.

Note: To cover existing holes in wood or metal doors use filler plates (available for 1/4" (44 mm) thick doors only).

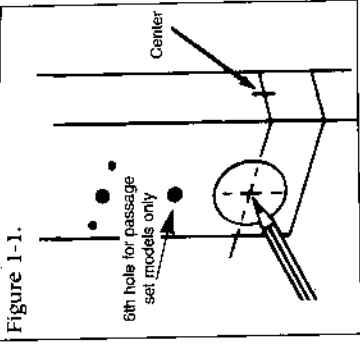

Figure 1-1.

INSTALLING THE LATCH

3

- 1 • Insert the latch into the 1" (25 mm) hole until the face plate butts up against the door edge. Make sure the bevel of the latch bolt faces the same direction as the door swings to close (see Figure 3-1).
- 2 • If necessary, draw a line around the face plate, then remove the latch. Use a sharp 1" (25 mm) wood chisel to remove approximately 1/8" (3 mm) of material or enough for the face plate to be perfectly flush with the edge of the door.
- 3 • Insert the latch into the 1" (25 mm) hole in the door edge until the latch face plate is flush with the door edge.
- 4 • Secure the latch to the door with two of the 3/4" (19 mm) screws provided (item "I" on checklist).

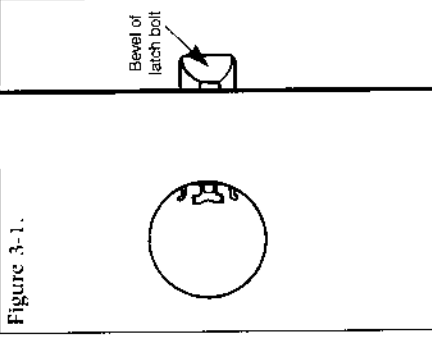

Figure 3-1.

DRILLING THE HOLES

2

- 1 • Use a hole saw with center guide drill bit to drill the 2 1/8" (54 mm) hole; apply pressure evenly until the circular blade cuts the first side of the door and the tip of the pilot bit emerges through the other side, then stop.
- 2 • Drill through the other side of the door until the 2 1/8" (54 mm) circular hole is completed.
- 3 • Use a hole saw with center guide drill bit to drill the 1" (25 mm) hole in the door face. Passage feature models require an additional 1" (25 mm) hole in the door face (repeat same drilling procedure as before).
- 4 • Use standard drilling bits to drill the two 1/4" (6 mm) holes for the 2 1/2" (64 mm) mounting screws.
- 5 • Drill the final 1" (25 mm) hole for the latch through the edge of the door. Drill until the hole saw is visible through the 2 1/8" (54 mm) hole, then stop.

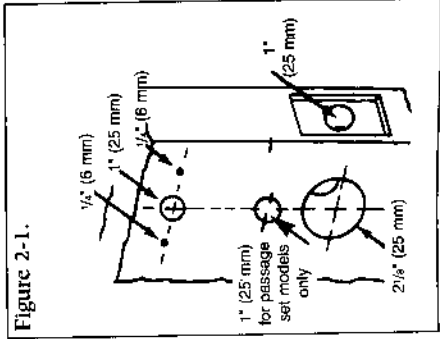

Figure 2-1.

ADJUSTING THE LOCK FOR DOORS 1 1/2" (38 mm) TO 1 7/8" (46 mm) THICK

4a

The 1000 Series lockset has been preassembled at the factory to accommodate doors 1 5/8" (41 mm) to 1 7/8" (46 mm) thick.

For doors 1 3/8" (35 mm) to 1 1/2" (38 mm) thick, adjust lock as follows:

- 1 • Remove the back plate assembly by removing the six back plate screws.
- 2 • Remove the cylindrical drive unit from the back plate assembly by removing the four screws from the inside of the back plate.
- 3 • Remove (and discard) the spacer located between the back plate and the cylindrical drive unit.
- 4 • Remount the cylindrical drive unit onto the back plate using the shorter screws provided (item "K" from the checklist).
- 5 • Remove the cross pin from position B on the drive shaft.
- 6 • Reposition the cross pin in position C on the drive shaft.
- 7 • Reinstall the back plate assembly onto the front lock case.

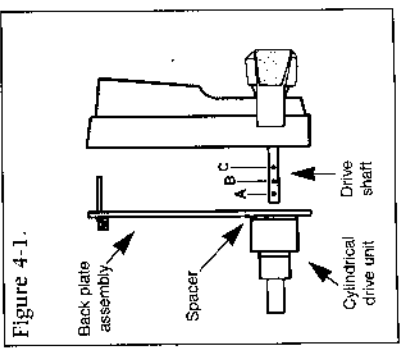

Figure 4-1.

ADJUSTING THE LOCK FOR DOORS 2" (51 mm) TO 2 1/4" (57 mm) THICK

For doors 2" (51 mm) to 2 1/4" (57 mm) thick, adjust the lock as follows:

1. Remove the back plate assembly by removing the six back plate screws.
2. Remove the cylindrical drive unit from the back plate assembly by removing the four screws from the inside of the back plate.
3. Insert the extra spacer provided in the accessory pack (item "F" on the checklist) between the cylindrical drive unit and the back plate. Be sure that the sharp edges are facing each other (see Figure 4-2).
4. Remount the cylindrical drive unit onto the back plate using the four 3/16" (17 mm) screws provided (item "L" on checklist).
5. Add a cross pin (item "H" on the checklist) in position **A** on the drive shaft (see Figure 4-3).
6. Remount the back plate assembly onto the front lock case.

WARNING: Damage may result if the lever hits against either the wall or the wall stop. In such a case, ALL warranties are null and void.

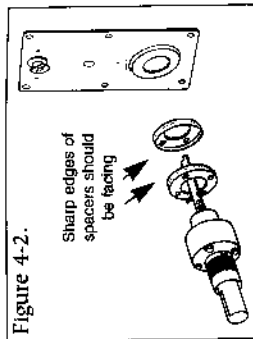

Figure 4-2.

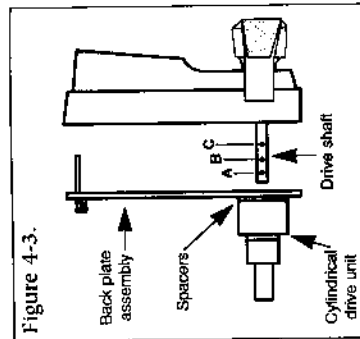

Figure 4-3.

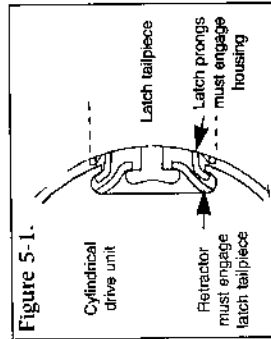

Figure 5-1.

1. Remove the inside lever by depressing the spring loaded retaining clip visible through the poke hole.
2. Pull the lever while releasing the retaining clip.
3. Remove the lever from the lock body.
4. Align the latch and the cylindrical drive unit by depressing the latch bolt slightly. Make sure that the latch and cylindrical drive unit engage each other as shown in Figure 5-1.

TESTING THE OPERATION OF THE LOCK

1. Enter the factory-set combination: Press buttons 2 and 4 at the same time (release), then press button 3 (release). You should feel a "click" as each button is pressed.
2. Turn the lever to the stop position and hold. Make sure the latch is fully retracted.
3. Release the lever. The latch should return to the fully extended position.
4. Turn the inside drive sleeve to the stop position and hold (see Figure 6-2). The latch will retract until it is flush with the face plate. Release the sleeve — the latch should return to the fully extended position.

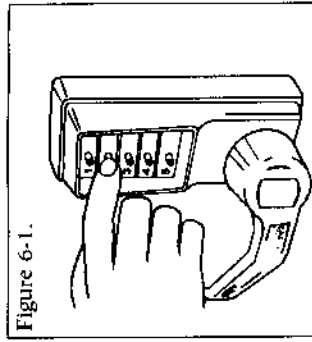

Figure 6-1.

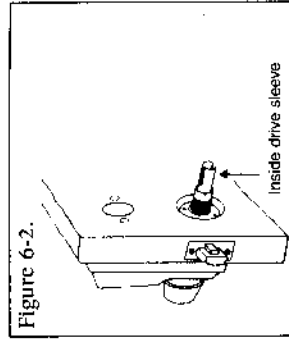

Figure 6-2.

INSTALLING THE REINFORCEMENT PLATE

1. Place the reinforcement plate over the inside drive sleeve as shown in Figure 7-1.
2. Insert the two 2 1/2" (64 mm) screws through the reinforcement plate into the 1/4" (6 mm) holes drilled in the door.
3. Tighten the screws to secure the lock housing to the door. The reinforcement plate should be parallel with the edge of the door.

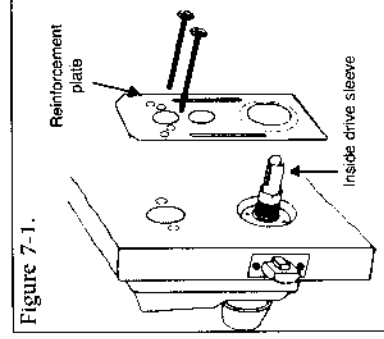

Figure 7-1.

8 INSTALLING THE PASSAGE SET FOR MODELS 1031, 1041, 1051 & 1061 ONLY

- 1• Insert the passage set plug assembly on the turn knob into the opening in the trim plate and retain it with the clip from inside (see Figure 8-1).
- 2• Shorten the tailpiece as necessary by breaking off at the score marks.

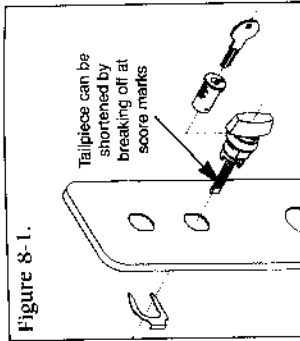

Figure 8-1.

9 INSTALLING THE INSIDE TRIM PLATE

- 1• Position the trim plate over the reinforcement plate (see Figure 9-1).
- 2• Gently screw the threaded ring onto the cylindrical drive unit. If you encounter difficulty during Step 2, remove the trim plate and readjust the reinforcement plate. **Do not force the threaded ring.**
- 3• Tighten the threaded ring using the spanner wrench provided (item "I" on checklist). See Figure 9-2.

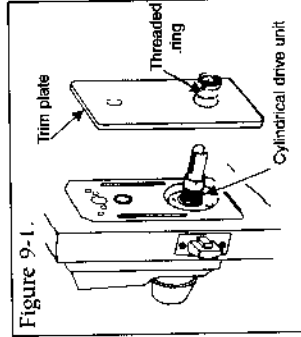

Figure 9-1.

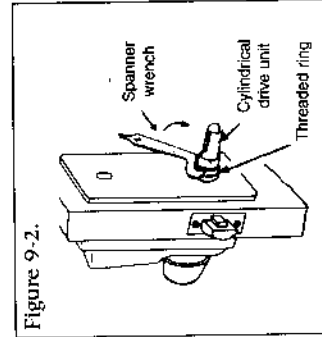

Figure 9-2.

10 INSTALLING THE INSIDE LEVER

10

- 1• Place the lever on the inside drive sleeve. Locate the retaining clip through the poke hole in the collar of the knob. If the threaded ring covers this poke hole, loosen the ring and align the hole in the ring with the hole in the collar.
- 2• Depress the retaining clip using the pointed tip of the spanner wrench (see Figure 10-1).
- 3• Slide the inside lever on while removing the spanner wrench — the retaining clip will snap back into place.
- 4• Retighten the threaded ring if it was loosened.
- 5• Turn the inside lever to the stop position and hold. The latch should retract smoothly until it is flush with the face plate.
- 6• Release the lever — the latch should return to the fully extended position.

Figure 10-1.

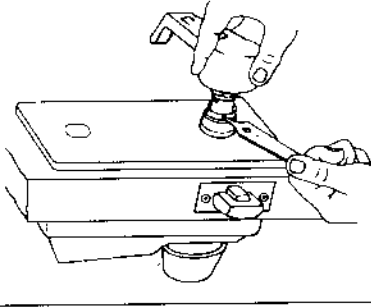

11 INSTALLING THE COMBINATION CHANGE ASSEMBLY

11

- 1• Insert the DF-59 key into the cylinder of the combination change assembly.
- 2• Insert the threaded bolt through the hole in the trim plate and into the mounting stud located in the 1" (25 mm) diameter cutout. See Figure 11-1. **No retainer clip is required.**
- 3• Turn the key clockwise until the collar of the cylinder plug assembly butts up to the trim plate. **CAUTION:** do not overtighten. The key can be removed in either the vertical or horizontal position.
- 4• If necessary, shorten the threaded bolt to obtain proper securing.

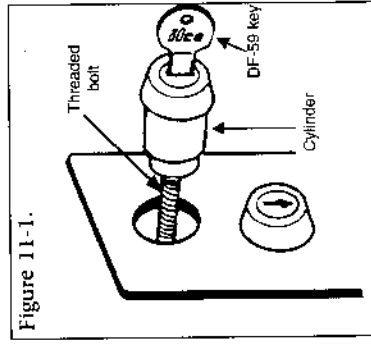
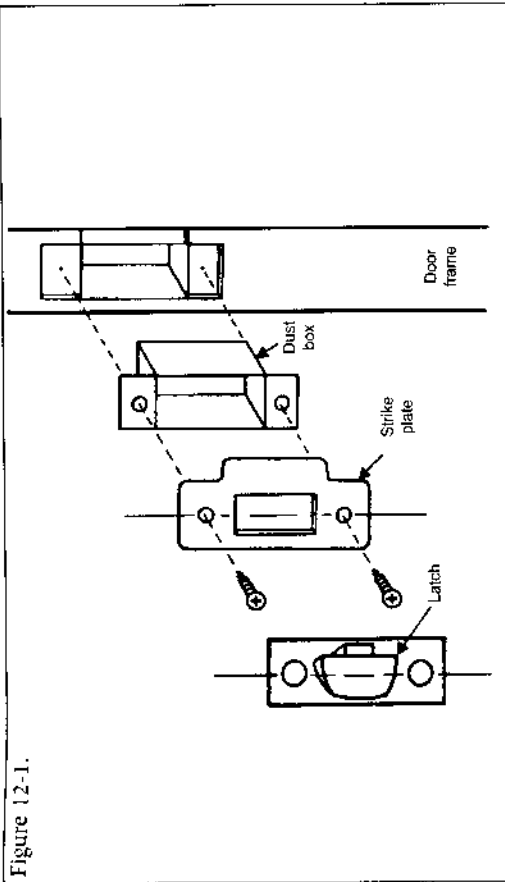

Figure 11-1.

Figure 12-1.



- 1• Mark the location of the strike on the door frame according to the template. Make certain that the line through the screw holes of the strike is aligned with the line through the screw holes on the face of the latch when the door is closed (see Figure 12-1).
- 2• Mortise the door frame (for dust box) to a minimum depth of $\frac{3}{4}$ " (19 mm). This will guarantee that the latch can be fully extended into the door frame. (The supplied ILCO UNICAN dust box must be used.)
- 3• Place the dust box in the mortised cutout. Secure the strike plate with two of the $\frac{3}{4}$ " (19 mm) screws provided (item "J" on checklist). If necessary, draw a line around the strike. Use this line as a guide to cut out a minimum of $\frac{1}{16}$ " (2 mm) of material or enough to make the strike plate flush with the door frame.

CAUTION: Check the operation of the latch by making sure that the dead latch stops against the strike plate, and does not slip into the strike opening when the door is closed (see Figure 12-2). If this situation occurs, then a total lockout may result. This will cancel our warranty of the complete lock mechanism.

Note: If there is a gap between the edge of the door and the frame (or in the case of double doors, the edge of the door and the edge of the door) of more than $\frac{1}{4}$ " (6 mm) the dead latch will fail to engage the strike jamb.

If necessary, correct the door over-travel by using the rubber bumpers provided in the accessory pack (item "G" on checklist) as described on page 15.

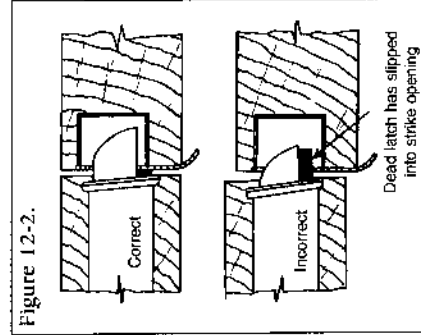

Figure 12-2.

FOR YOUR SECURITY THE COMBINATION MUST BE CHANGED WHEN THE LOCK IS INSTALLED.

The door must be open.

On models with the passage feature, make sure the passage feature is disengaged.

- 1• Insert the DF-59 control key into the combination change plug assembly and unscrew the cylinder by turning the key counterclockwise. Remove the combination change plug to gain access to the combination change sleeve (see Figure A-1).
- 2• Turn the outside lever to the stop position then release.
- 3• Enter the existing combination. On new installations, use the factory-set combination: press 2 and 4 simultaneously, (release), then 3 (release). You should feel a "click" as each button is pressed.
- 4• Insert the spanner wrench as shown in Figure A-2 to engage the combination change sleeve. Gently turn the spanner wrench clockwise to the stop position (a slight click should be felt), then turn the spanner wrench counterclockwise to the stop position (see Figure A-3). Remove the spanner wrench.
- 5• Turn the outside lever to the stop position then release.
- 6• Choose your new combination, write it on page 10, then enter the new combination — press buttons carefully (a slight click should be felt as each button is depressed).

Note: You can use one button or all five for a combination, but each button can only be used once. You can press two or more buttons simultaneously as a step in the combination.

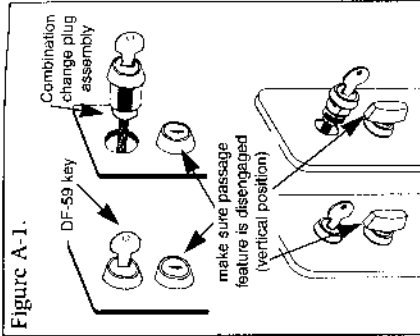

Figure A-1.

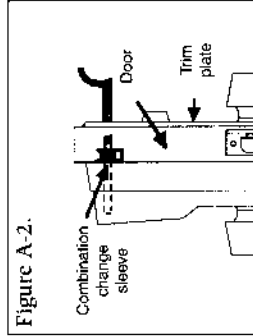

Figure A-2.

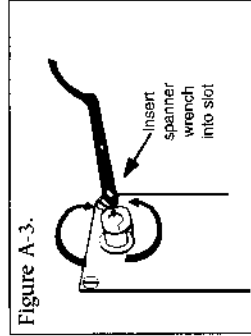

Figure A-3.

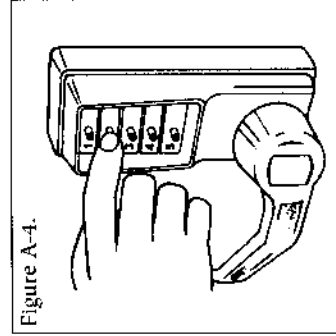

Figure A-4.

A CHANGING THE COMBINATION

Continued

7. Turn the outside lever once, all the way, until it stops, hold in position and make sure the latch is retracted. Release the lever. Turn the lever clockwise again to the stop position. At this point, the latch should not retract unless you enter the new combination (see Figure A-5).
8. Replace the combination change plug assembly by screwing it in clockwise with the key — do not overtighten (see Figure A-6). Remove the key and store it in a secure area with these instructions and the spanner wrench.

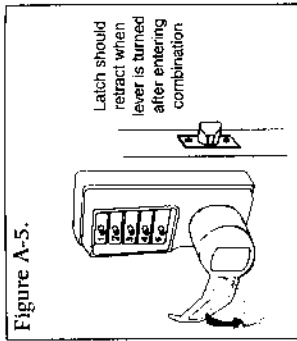

Figure A-5.

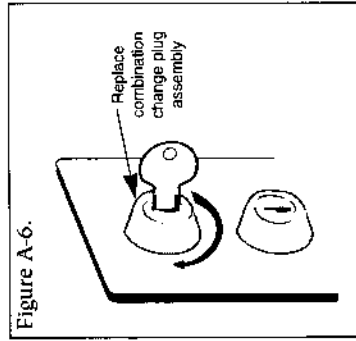

Figure A-6.

C USING THE PASSAGE FUNCTION

MODELS L1031, L1041, L1051, L1061 ONLY

WARNING: When using the passage function, the following procedure must be followed; otherwise, damage may result.

1. Enter the existing combination.
2. Turn the outside lever to the stop position and hold.
3. Keeping the outside lever in its turned position, rotate the passage turn knob or keyed lock to the right to the horizontal position (see Figure C-1).
4. Release the outside lever. The passage function is now activated, so the door can be opened without entering a combination.

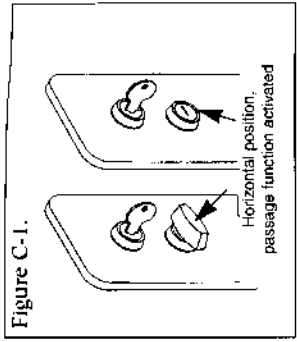

Figure C-1.

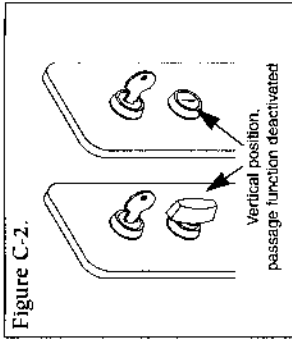

Figure C-2.

To Cancel the Passage Function

Rotate the passage turn knob or keyed lock to the left (counterclockwise) to the vertical position (see Figure C-2). The passage function is now deactivated, so the outside lever will not retract the latch unless the combination is entered.

Note: Change the combination only when the passage function is deactivated.

B COMBINATION SETTING RECORD

Combination # _____

Date _____

PRESERVING THE LATCH

The door to frame relationship is critical for the performance and durability of the ILCO UNICAN latch mechanism. The vertical and horizontal center lines are important when positioning the lock, the strike, and the latch, and must be according to ANSI* standard A115.2. To insure proper installation, you must use the supplied strike plate.

Rubber bumpers (supplied with the lock) may be required to properly align the door. The adjustment becomes more significant with metal frames, wood doors, and filler plates when replacing existing hardware.

Figure D-1 shows the proper alignment between the door, the frame, the latch, and the strike plate. When the door rests against the door stop, the dead latch should seat against the strike plate. At this point, you will notice a tolerance of $\frac{1}{32}$ " (2 mm), basic according to ANSI standards. If the door travels beyond this tolerance, the dead latch may slip into the strike box with the anti-friction device, causing the latch to jam, and create a lock-in and lock-out condition. (see Figure 12-2 on page 8). This condition can be prevented by adding bumpers to the door stop.

* American National Standards Institute — contact ILCO UNICAN for further information.

Installing Rubber Bumpers (included with lock)

1. Close the door and apply pressure making sure the dead latch rests on the strike plate.
2. Standing on the door stop side of the door, check for gaps between the door and the door stop on all three sides of the frame (left, right, and top). Mark locations where the gaps are approximately $\frac{3}{16}$ " (5 mm) (see Figure D-2).
3. Make sure these locations are free of grease and dust.
4. Peel the bumpers from their protective backing without touching the adhesive surface and stick them on the marked locations on the door stop.
5. Allow 24 hours for adhesive to set before testing. The door may be operated normally during this time.

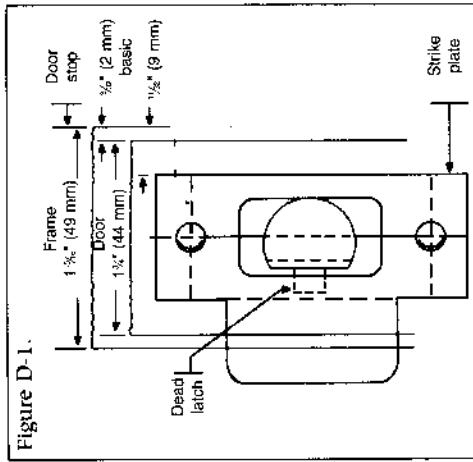

Figure D-1.

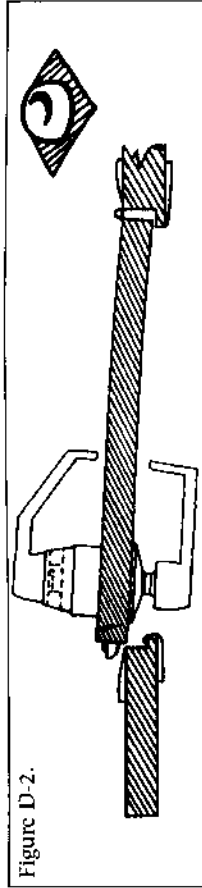

Figure D-2.

CLEARING A LOST COMBINATION

There is no procedure for determining an unknown combination from the front of the lock. A lost combination must be cleared by removing the combination chamber from the lock housing, then a new combination can be set.

1. Remove the back plate from the lock by removing the six back plate screws.
2. Lift the chamber linkage off the control shaft by prying up with a flat blade screwdriver (see Figure E-1).
3. Remove the combination chamber by removing the two screws.
4. Remove the shaft bushing.
5. Remove the chamber cover marked "Simplex" (see Figure E-2) by gently tapping the lip of the back cover at the control shaft end of the chamber (see Figure E-3) with a screwdriver to detach it from the staked joints.
6. Lay the chamber down as shown in Figure E-4.
7. With tweezers, or other tool, slide the "E" ring off the unlocking slide stud (see Figure E-4), then gently lift the end of the unlocking slide over the unlocking slide stud. **Note:** The unlocking slide is under spring tension and will be easier to lift if pushed to the left to ease tension. Swing the unlocking slide sufficiently to clear the gears, no further than shown in Figure E-5.
8. Depress the lockout slide. The gears are now free to rotate.
9. Turn each gear so that the slots are aligned as in Figure E-6.
10. Return the unlocking slide over the unlocking slide stud while making certain the five toes are engaged in the five gear pockets. It may be necessary to adjust each gear slightly to make proper alignment between toes and gear slots (see Figure E-7).

Replace the "E" ring on the stud. Your chamber will now resemble Figure E-7 and is ready for reassembly with the lock housing.

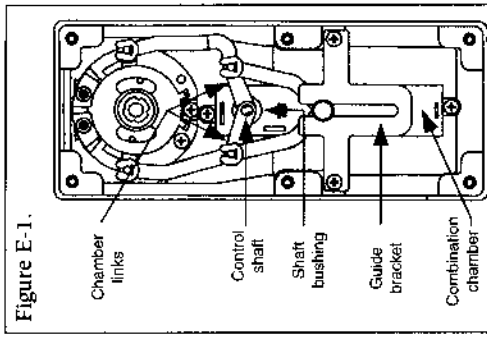

Figure E-1.

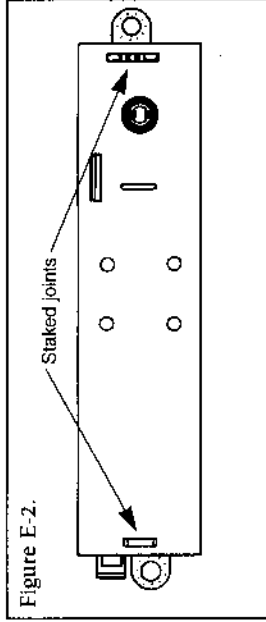

Figure E-2.

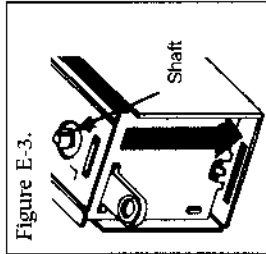











Figure E-3.

-  = Symptom/problem
 = Possible cause
 = Remedy



  Outside lever when turned always retracts latch without depressing any buttons.



Lock is in zero combination.

  Follow the procedure for changing a combination (Appendix A - page 9) except omit step 3 (do not enter the existing combination).

  The threaded rod from the control lock remains in the lock after it is removed.



Control lock was over tightened when put on the door.

  Using a vice-grip wrench, turn at the middle of the rod, to avoid stripping the active threads, and turn counterclockwise to remove the rod from the lock. Put the rod back into the control lock and tighten spring nut.

  After entering a new combination, the lock works one time only; then the lock fails to open.

Buttons of intended combination were not fully depressed when changing combination.

 Refer to Appendix E (page 13) - Clearing a Lost Combination.

  Correct code is depressed, outside lever turns about 10 degrees and latch partially retracts then jams. Key override in outside lever cannot retract latch. Inside lever cannot retract latch.



The dead latch is wedged into the strike box, caused by improper door, door stop, and strike plate alignment.

 Saw or break the latch to gain access or to get out. Replace the latch and adjust the door/frame alignment (see Appendix D - page 12) to prevent a similar occurrence. If outside lever was forced to retract the latch, the chamber control shaft may have twisted. Replace the chamber.



 = Problème



 = Cause possible

 = Solution



  Sous l'action du levier extérieur, le pêne se rétracte sans que vous n'ayez appuyé sur aucun bouton.



 La serrure ne possède aucune combinaison.

  Vous reporter à l'appendice A - page 9, Changement de la combinaison. Ne pas tenir compte de l'étape 3 (combinaison déjà existante).



  Le boulon fileté du cylindre reste dans la serrure lorsqu'on le retire.



 Le cylindre a été vissé trop serré lors de son installation.

  À l'aide d'une pince-étau, serrer au milieu du boulon pour ne pas endommager le filetage, puis tourner en sens horaire contraire pour retirer le boulon du cylindre. Remettre le boulon en place dans le cylindre, puis serrer l'écrou-ressort.



  Après avoir entré la nouvelle combinaison, la serrure fonctionne une première fois, puis interdit l'accès par la suite.

 Les boutons-poussoirs de la combinaison choisis n'ont pas été pressés complètement au moment de changer la combinaison.

  Vous reporter à l'appendice E - page 13, Annulation d'une combinaison inconnue.

  La bonne combinaison est entrée, le levier extérieur s'abaisse jusqu'à environ un angle de 10 degrés, le pêne se rétracte partiellement, puis se bloque. Ni la clé de commande prioritaire ni le levier intérieur ne peuvent faire rétracter le pêne.

 Le contre-pêne de sécurité est bloqué dans le boîtier antid poussière en raison d'un mauvais alignement de la porte, de la butée de porte et de la gâche.

  Scier ou forcer le pêne pour entrer ou sortir. Pour empêcher que cette situation ne se reproduise, vous reporter à l'appendice D - page 12, Alignement entre la porte et le jambage. L'arbre de commande de la chambre à combinaison peut avoir été tordu en forçant le levier extérieur pour faire rétracter le pêne. Remplacer le pêne et la chambre à combinaison.

TEMPLATE A

(without passage set)
LEFT HAND

NOTE: Lock will accommodate doors 1 3/8" (35mm) to 2 1/4" (57mm) thick. Suitable reinforcement shall be provided by the hollow metal door manufacturer to prevent collapsing of door. When door silencers are to be installed, proper allowances must be made for strike location.

CAUTION: MARK ACCURATELY - BORE STRAIGHT

TOP

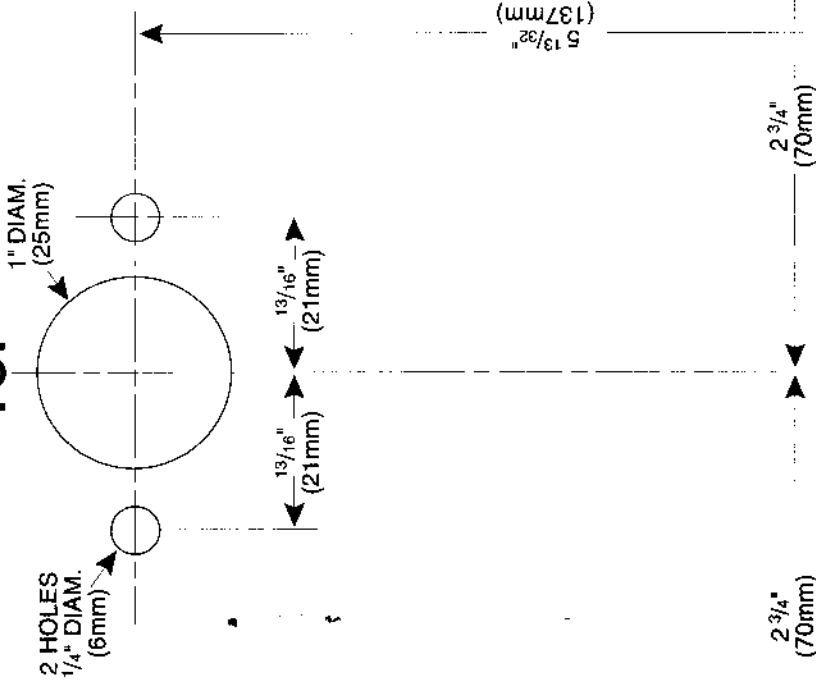

MARK CENTER OF DOOR THICKNESS

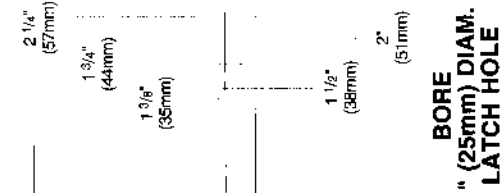

BORE 1" (25mm) DIAM. LATCH HOLE

THIS FLAP FOLDS OVER THE EDGE OF THE DOOR
BE SURE THE FOLD IS EXACTLY ON THE LINE

INSERT LATCH, MARK AROUND FACE PLATE OF LATCH, MORTISE TO DEPTH REQUIRED

INSERT LATCH, MARK AROUND FACE PLATE OF LATCH, MORTISE TO DEPTH REQUIRED

BOTTOM

THIS FLAP FOLDS OVER THE EDGE OF THE DOOR
BE SURE THE FOLD IS EXACTLY ON THE LINE

TEMPLATE A

(without passage set)
RIGHT HAND

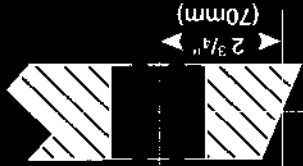

CAUTION
APPLY TEMPLATE AND DRILL FROM OUTSIDE BUT COMPENSATE FOR DOOR BEVEL IF ANY.

MARK CENTER OF DOOR THICKNESS

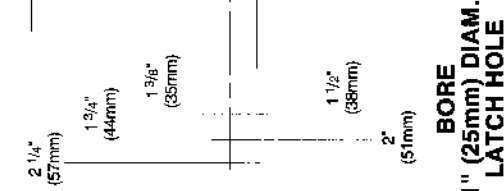

BORE 1" (25mm) DIAM. LATCH HOLE

